



ASX: G1A FRA: GM6

Investor Update August 2021

"We acknowledge the Nharnuwangga Wajarri and Ngarlawangga peoples, past, present and emerging who are the Traditional Custodians of the land on which the Abra Project is located"



Disclaimer

Cautionary statement – Reference to FS. This report refers to the Abra Base Metals Project (“Abra” or the “Project”) Feasibility Study (“FS”). A summary of the FS and material assumptions was published by Galena Mining Ltd (“Galena”) (ASX: 22 July 2019).

Environmental approvals, mining tenements and approvals, other governmental factors and infrastructure requirements for selected mining methods and for transportation to market were not included as modifying factors for the Ore Reserve contained in this report as they were all analysed in detail and determined not to pose any practical or economic restriction to the selected mining and processing model. Furthermore, all other material assumptions (eg, with respect to financial assumptions, metallurgy, mineralogy and geotechnical etc.) that were made in the previously announced FS have not materially changed, continue to apply.

Process and engineering designs for Abra’s FS were developed to support capital and operating estimates to an accuracy of $\pm 10\%$. Key assumptions that the FS was based on (including those defined as Material Assumptions under ASX Listing Rule 5.9.1) are outlined in the ASX announcement of 22 July 2019 and its Appendix 1. Galena believes the production target, forecast financial information derived from that target and other forward-looking statements included in that announcement and this presentation are based on reasonable grounds.

A number of key steps need to be completed in order to bring Abra into production. Many of these steps are referred to in this announcement. Investors should note that if there are delays associated with completion of those steps, outcomes may not yield the expected results (including the timing and quantum of estimated revenues and cash flows).

The economic outcomes associated with the FS are based on certain assumptions made for commodity prices, concentrate treatment and recovery charges, exchange rates and other economic variables, which are not within the Company’s control and subject to change from time to time. Changes in such assumptions may have a material impact on the economic outcomes (including the timing and quantum of estimated revenues and cash flows).

To develop the Project as per the assumptions set out in the FS may require additional capital. Investors should note that any failure to procure the required additional capital may result in a delay, change in nature and scale, or even suspension of the Project.

Cautionary statement – FS Mine Model The mineralised material scheduled to be mined and processed in the FS (“FS Mine Model”) includes a mix of material taken from Probable Ore Reserves (67%) and Inferred Mineral Resources (33%), with no reduction factor applied to the tonnes and grades of the Inferred Mineral Resources. Inferred Mineral Resources have a lower level of geological confidence and can’t be included in the calculation of Ore Reserves, and there can be no guarantee that a Mineral Resource estimate update will convert Inferred Mineral Resources to Indicated Mineral Resources or return the same grade and tonnage estimation. This may affect mining studies and outcomes (including economic) from the FS.

At the time of publication of the FS, Galena was completing the 2019 project development drilling program and subsequent to that a further infill drilling program was completed in 2020. The results of the combined drilling programs subsequent to the FS provided confidence and validation to the Company in regard to the assumptions and geological models which underpin FS, and resulted in the completion of an updated Mineral Resource estimate (the “April 2021 Resource”) where the total Resource was amended to 34.7Mt at 7.2% lead and 16g/t silver, including 16.9Mt of Indicated material at 7.4% lead and 17g/t silver. Based on the status of geological information, Galena believes it has a strong basis for inclusion of certain Inferred Mineral Resource material in the FS Mine Model (defined below) at this time and whilst remaining within feasibility study level tolerances. To further test its basis, Galena ran the FS financial model on a check scenario assuming a zero grade for any Inferred Mineral Resource material in the FS Mine Model and that produced a substantial positive NPV outcome.

Forward looking statements - The contents of this presentation reflect various technical and economic conditions at the time of writing. Given the nature of the resources industry, these conditions can change significantly over relatively short periods of time. Consequently, actual results may vary from those in this presentation.

Some statements in this presentation regarding estimates or future events are forward-looking statements. They include indications of, and guidance on, future earnings, cash flow, costs and financial performance. Forward-looking statements include, but are not limited to, statements preceded by words such as “planned”, “expected”, “projected”, “estimated”, “may”, “Scheduled”, “intends”, “anticipates”, “believes”, “potential”, “predict”, “foresee”, “proposed”, “aim”, “target”, “opportunity”, “could”, “nominal”, “conceptual” and similar expressions.



Disclaimer (continued)

Forward looking statements (continued) - Forward-looking statements, opinions and estimates included in this presentation are based on assumptions and contingencies which are subject to change without notice, as are statements about market and industry trends, which are based on interpretations of current market conditions. Forward-looking statements are provided as a general guide only and should not be relied on as guarantee of future performance. Forward-looking statement may be affected by a range of variables that could cause actual results to differ from estimated results and may cause the Company's actual performance and financial results in future periods to materially differ from any projections of future performance or results expressed or implied by such forward-looking statements. So there can be no assurance that actual outcomes will not materially differ from these forward-looking statements.

Competent Person's statement - The information in this report related to the Abra Ore Reserve is based on work completed by Mr Roger Bryant, BEng (Mining, Member AUSIMM). Mr Bryant was an employee of Galena Mining Ltd at the time the Ore Reserve was prepared. Mr Bryant has sufficient experience relevant to the style of mineralisation and type of deposit under consideration and to the activity which he is undertaking to qualify as a Competent Person as defined in the 2012 Edition of the Australasian Code for Reporting of Exploration Results, Exploration Targets, Mineral Resources and Ore Reserves. Mr Bryant consents to the inclusion in the report of the matters based on this information in the form and context in which it appears.

The information in this report related to the Abra April 2021 Resource is based on work completed by Mr Angelo Scopel BSc (Geol), MAIG, a fulltime employee of Galena Mining and Mr Mark Drabble B.App.Sci. (Geology), MAIG, MAusIMM, Principal Consultant at Optiro Pty Ltd. Mr Scopel was responsible for data review and QAQC, and. Mr Drabble was responsible for the development of the geological model, resource estimation, classification and reporting. Mr Scopel and Mr Drabble have sufficient experience relevant to the style of mineralisation and type of deposit under consideration and to the activity which they are undertaking to qualify as a Competent Person as defined in the 2012 Edition of the Australasian Code for Reporting of Exploration Results, Exploration Targets, Mineral Resources and Ore Reserves. Mr Scopel and Mr Drabble consent to the inclusion in the report of the matters based on this information in the form and context in which it appears.

The information in this report to which this statement is attached that relates to exploration results and drilling data is based upon information compiled by Mr Angelo Scopel BSc (Geol), MAIG, a fulltime employee of Galena Mining. Mr Scopel has sufficient experience relevant to the style of mineralisation and type of deposit under consideration and to the activity which they are undertaking to qualify as a Competent Person as defined in the 2012 Edition of the Australasian Code for Reporting of Exploration Results, Exploration Targets, Mineral Resources and Ore Reserves. Mr Scopel consents to the inclusion in the report of the matters based on this information in the form and context in which it appears.

Not an offer - This presentation is for information purposes only. The presentation does not comprise a prospectus, product disclosure statement or other offering document under Australian law or any other law. This presentation does not constitute or form part of any invitation, offer for sale or subscription or any solicitation for any offer to buy or subscribe for any securities in Galena Mining Limited.

No liability - Galena Mining Limited has prepared this document based on information available to its at the time of preparation. No representation or warranty, express or implied, is made as to the fairness, accuracy or completeness of the information, opinions and conclusions contained in this presentation. To the maximum extent permitted by law, Galena Mining Limited, its related bodies corporate and the officers, directors, employees, advisers and agents of those entities do not accept any responsibility or liability for any loss arising from the use of the presentation or its contents or otherwise arising in connection with it.

Copyright notice - This presentation is protected by Australian and International copyright laws. Reproduction and distribution of the presentation or its contents (including but not limited to any charts, maps, diagrams, graphics, photos and text) without the written permission of Galena Mining Limited is prohibited.

© 2021 Galena Mining Limited.



Abra Project Timeline Summary

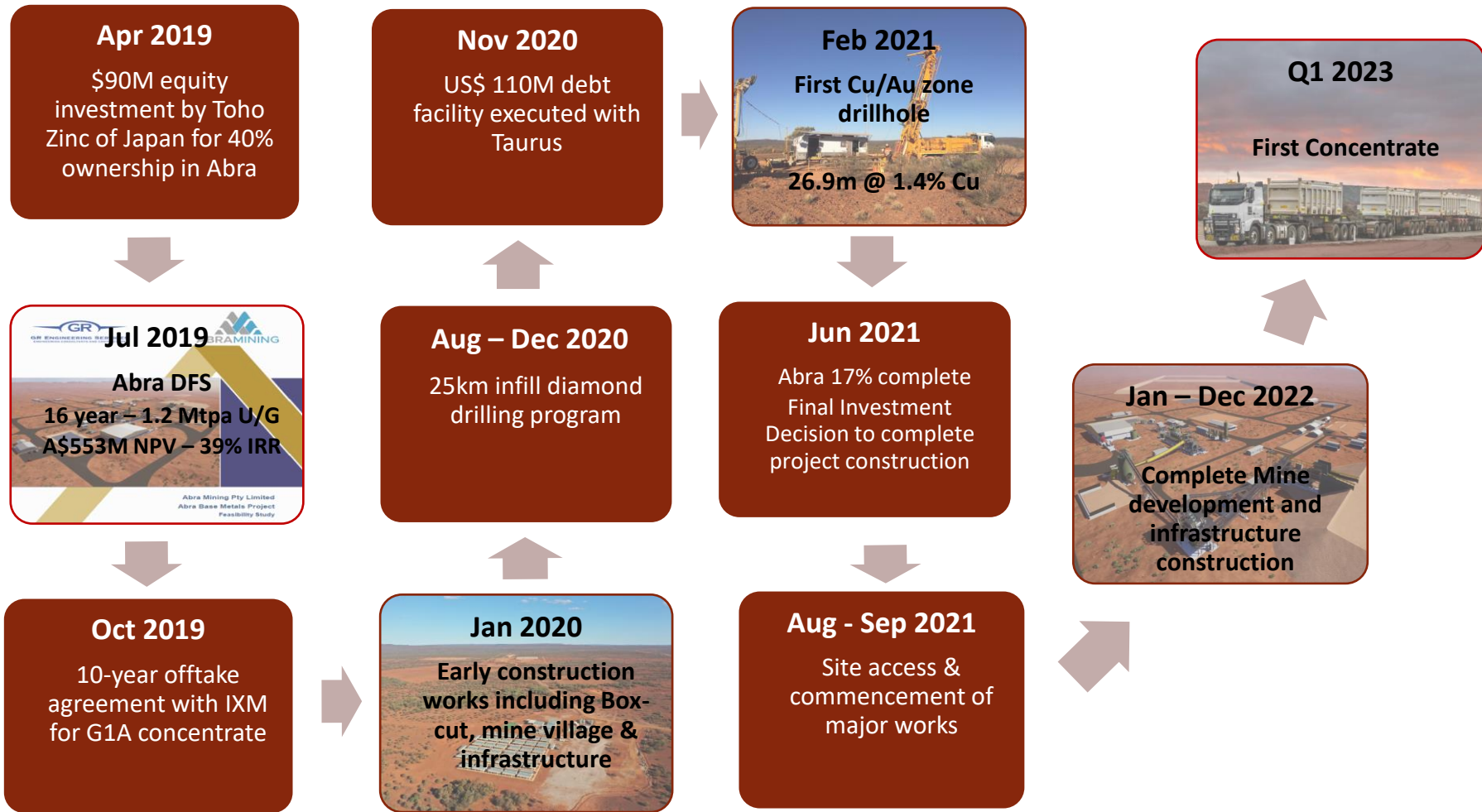

Australia's Next Base Metals Producer

- A high return Western Australian base metals project just completed final investment decision and on-track to produce in Q1 CY2023
- Set to produce 95ktpa of lead and 805kozpa of silver after ramp-up at cash costs among the lowest of global primary lead producers (C1 direct cash cost US\$0.44/lb)¹
- Funded to production through combination of:
 - Existing cash resources: \$96.2M as at 30 June 2021
 - Taurus debt facilities: ~\$107M (A\$ equivalent of undrawn US\$80M facilities). Initial drawdown of \$30M made by Abra (ASX: 25 June 2021).
- Large Mineral Resource backed by ~100km of drilling – 34.5Mt at 7.2% lead and 16g/t silver, open in all directions²
- Significant exploration targets surrounding Abra (107 km²) with growing zone of copper and gold mineralisation present below the lead-silver Resource
- Additional Jillawarra Project (100%) with 76km of greenfields exploration tenements (508 km²) with multiple advanced prospects for copper, lead, zinc and gold

Notes: (1) Source: FS see Galena ASX announcement (ASX: 22 July 2019). No reduction factor has been applied to the tonnes and grades of the Inferred Mineral Resources. Inferred Mineral Resources have a lower level of geological confidence and can't be included in the calculation of Ore Reserves, and there can be no guarantee that a Mineral Resource estimate update will convert Inferred Mineral Resources to Indicated Mineral Resources or return the same grade and tonnage estimation. This may affect mining studies and outcomes (including economic) from the FS. The Mineral Resource used for the basis of the FS parameters was completed in December 2018 (ASX: 18 December 2018). (2) Following further drilling since 2018, Galena has revised the Mineral Resource estimate (ASX: 28 April 2021).



Galena (ASX:G1A)

Summary

Ordinary shares on issue (ASX: G1A)	476.1M
Options / rights on issue ^{1,2,3}	20.1M
Share price (30 July 2021)	\$0.245/share
Market Capitalisation	\$116.6M
Cash balance (30 June 2021)	\$96.2M
Debt – US\$30M drawn of Taurus debt facilities (US\$80M undrawn remaining) plus US\$3M of undrawn advance payment facility from IXM	\$40.5M

Analyst coverage

Euroz-Hartleys	Mike Millikan
Petra Capital	Hugh Stackpool

Notes: (1) Options on issue pursuant to Placement in 2019 comprise of 1.25m having an exercise price of \$0.50 and expiry date of 26 March 2023, 1.25m having an exercise price of \$0.60 and expiry date of 26 March 2023, 1.25m having an exercise price of \$0.50 and expiry date of 17 April 2023 and 1.25m having an exercise price of \$0.60 and expiry date of 17 April 2023. (2) 11.0m contingent performance rights for CEO and CFO. (3) 4.1m employee share appreciation rights.

ASX: G1A (since IPO)

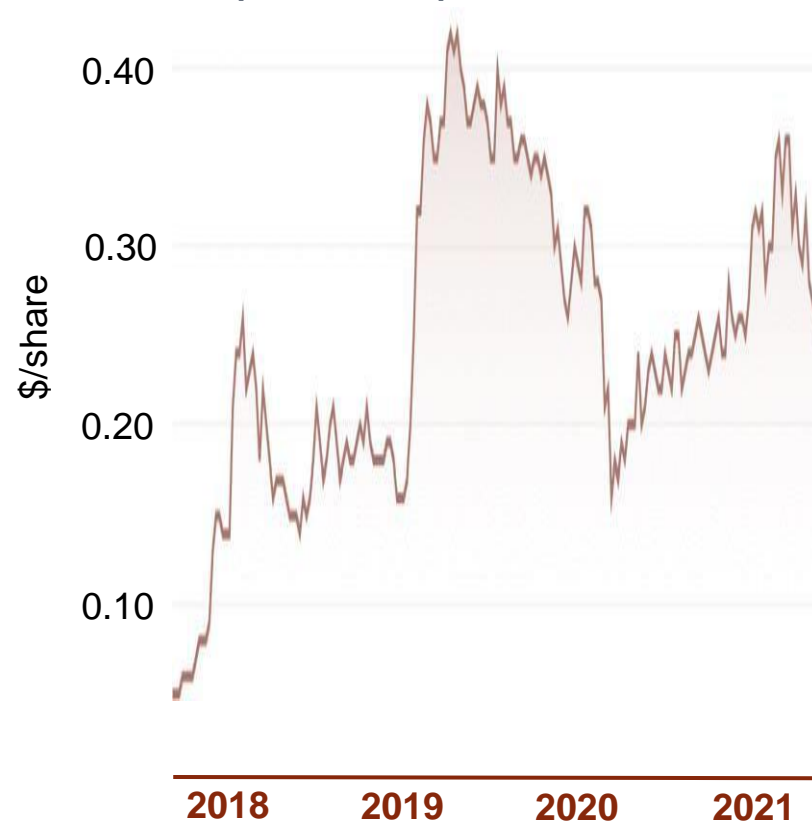

Source: www.asx.com.au



Board and Management



Tony James

Managing Director

Senior Mining Engineer

Midcap ASX mining company CEO and underground mine development experience



Adrian Byass

Non-Executive Chairman

Geologist and Economist

Mine development and board experience



Stewart Howe

Non-Executive Director

Mining Engineer and Finance

Global lead industry and large cap ASX mining company senior executive experience



Jonathan Downes

Non-Executive Director

Geologist

Geology, mine development, capital markets and board experience



Alexander Molyneux

Executive Director

Mining Executive and Financer

Mid cap ASX mining CEO, mine development and corporate finance experience



Craig Barnes

CFO

Chartered Accountant

Public company CFO, project financing, with joint-venture and treasury experience



Troy Flannery

CEO, Abra Mining JV

Mining Engineer

Underground mining and underground mine development experience



Peter Stregas

Abra GM

Mining Engineer

Experienced underground mine manager and site GM



A New Mine and A New Mineral Province in WA

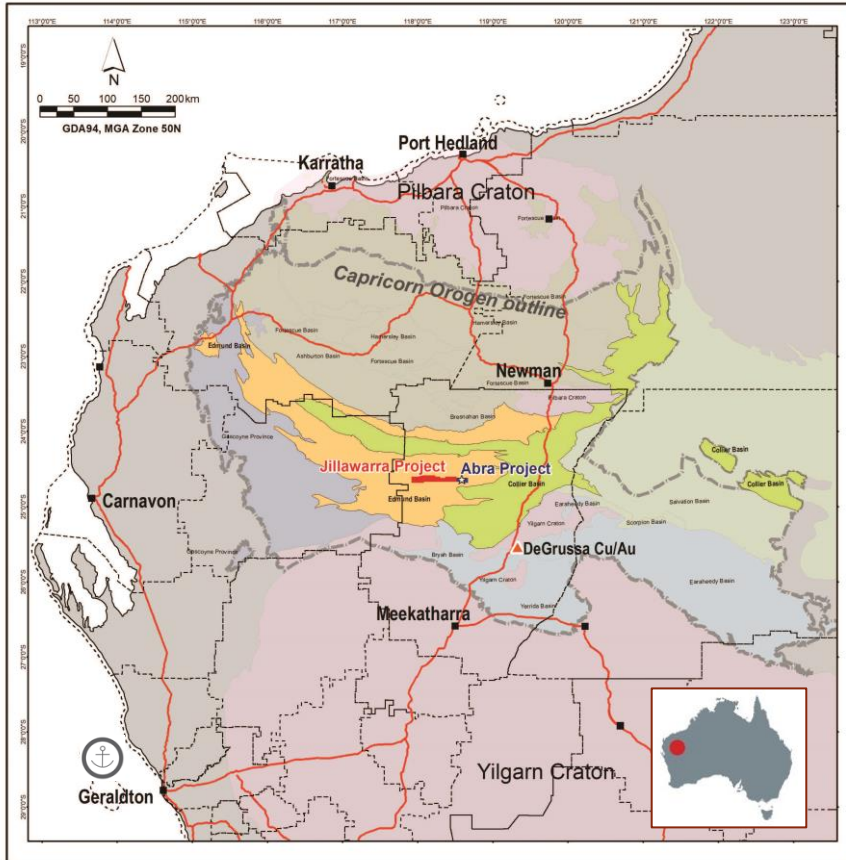

- Abra is located within Edmund sedimentary basin in the Gascoyne region of WA (*approximately 110km NW of Sandfire Resources' DeGrussa Mine*)
- On a granted Mining Lease with all major permits and native title arrangements in place
- Accessed by existing roads
- High-grade lead-silver concentrate will be trucked to Port of Geraldton in sealed half-height containers
- Port of Geraldton has all permits and infrastructure required to handle Abra's product (it currently handles similar product for other producers)
- MOU with port in place confirming capacity and access



Abra Deposit

Overlying stratiform mineralisation, known as the “Apron Zone” is largely galena-rich (ie, lead and silver), fed by mineralised breccia and vein zones called the “Core Zone”
 – Core Zone grades from lead-silver dominant upper levels to copper-gold at depth

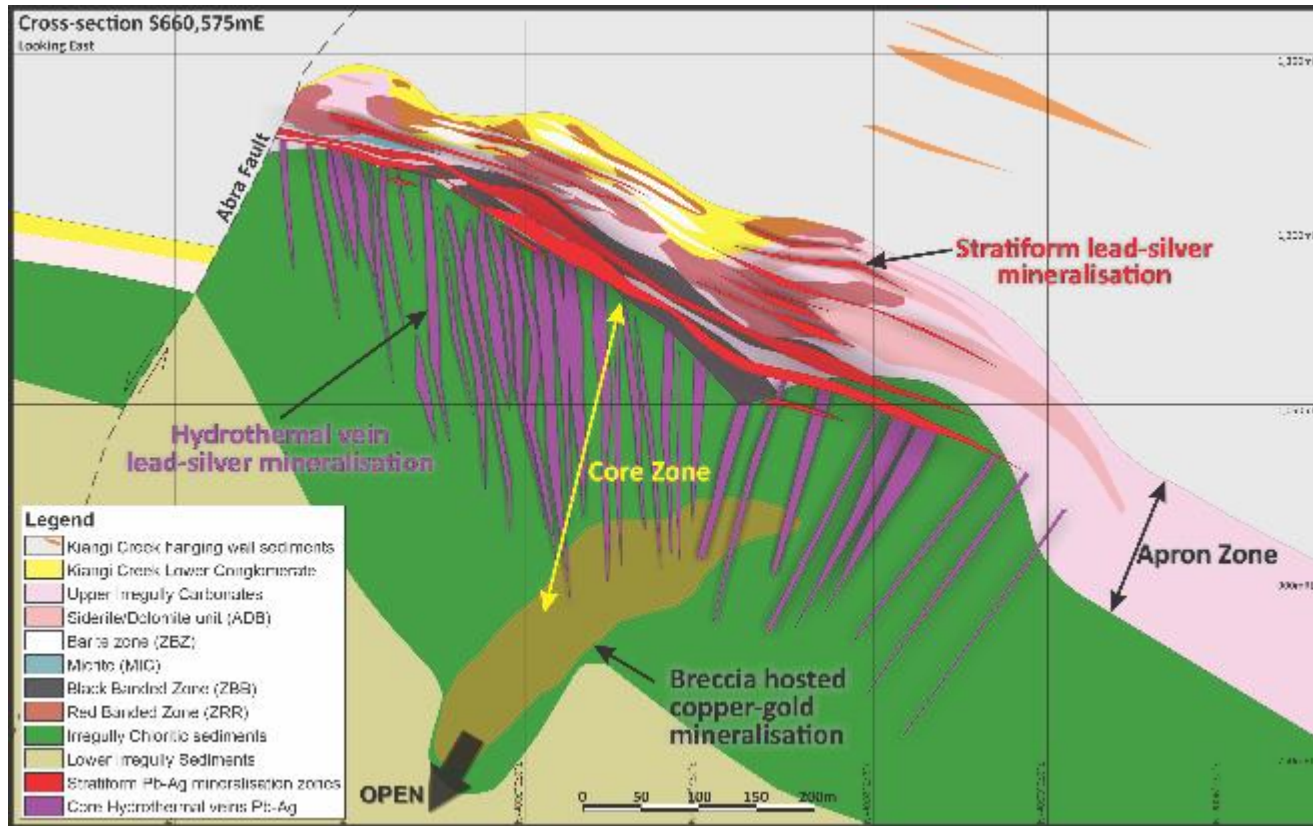

- Sediments deposited in a basin setting and deformed with large scale folding and faulting
- Hydrothermal fluids carrying lead, silver, zinc, copper and gold have risen through breccia and fault zones
- Mineralised fluids have risen to a sedimentary boundary and have ‘mushroomed’ sideways settling in preferential (dolomitic) units



Abra Mineralisation and Resource

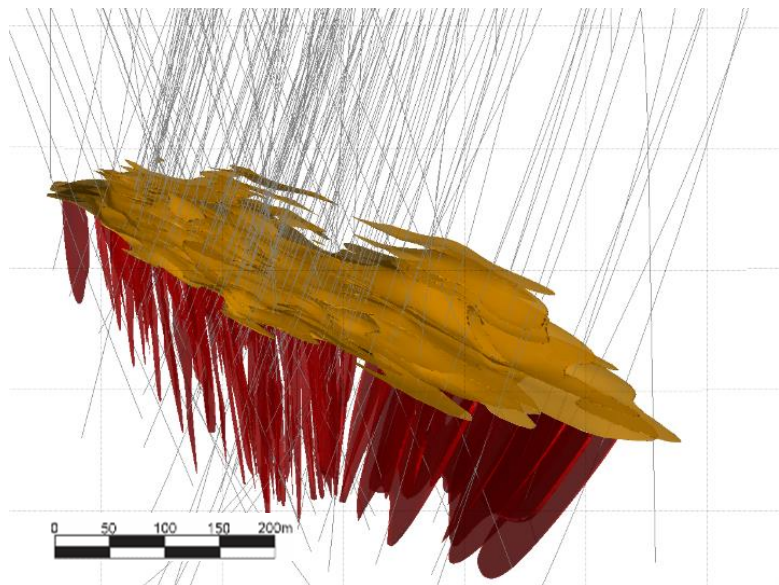

- Blind discovery in 1981 (Geopeko)
- 3D view shows resource wireframes at 5% Lead cut-off
- Apron & Core zones are shaded separately
- Rich in lead-silver in upper sections with copper-gold at depth
- Resource remains open at depth and in all lateral directions (North, South, East & West)
- Lead-silver Mineral Resource (April 2021) based on ~100km of cumulative linear drilling
- Resource contains 205 drill-holes
- Two-thirds of current database is based on new drill-holes completed by Galena over last 4 years (since ASX IPO)
- Independently estimated by Optiro

JORC Mineral Resource estimate (April 2021 Resource) at a 5% lead cut-off grade¹

<u>Resource classification</u>	<u>Tonnes (Mt)</u>	<u>Lead grade (%)</u>	<u>Silver grade (g/t)</u>
Indicated	16.9	7.4	17
Inferred	17.5	7.0	15
Total	34.5	7.2	16

Notes: (1) For more detail please see Galena announcement (ASX: 28 April 2021)



Abra Processing and Concentrate Production

- Metallurgical testing confirms high recoveries – 94% used in FS recovery work
- Conventional 3-stage crushing, grinding, flotation and filtration
- Product to be highest grade primary lead concentrate available globally 75% lead and 80 - 200g/t silver
- 40% of concentrate production to Toho Zinc on benchmark terms
- 60% of concentrate being Galena portion committed to IXM under 10-year contract providing a significant premium to benchmark (high quality concentrate)

Abra Plant & Infrastructure Layout



Source: GRES.



Abra Proposed Plant Flowsheet

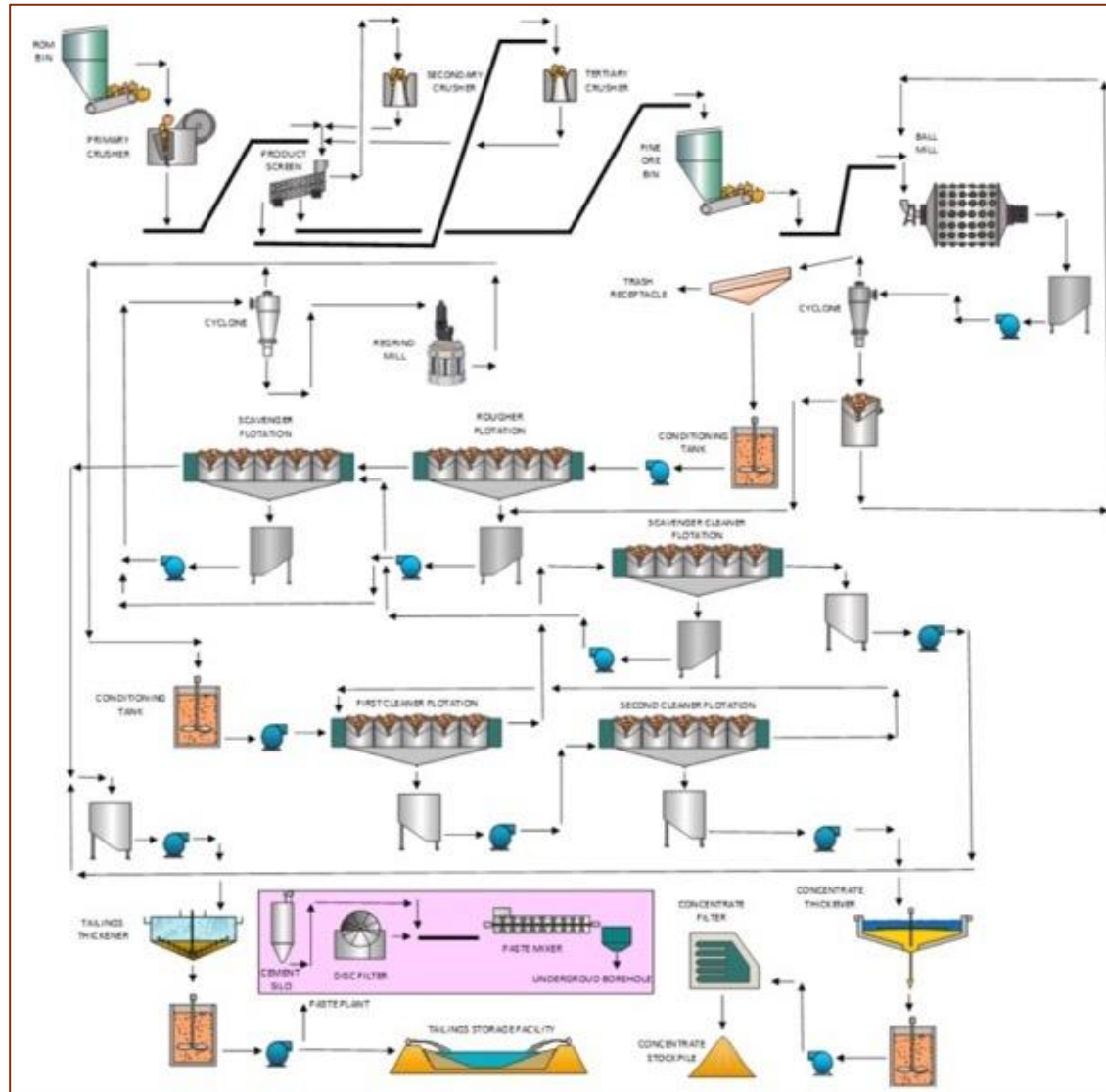

Source: GRES.

- Simple conventional sulphide base metals processing flowsheet
- Potential for future expansion and / or use for copper-bearing primary sulphide minerals
- GRES awarded EPC contract for plant and ancillary infrastructure under a guaranteed maximum price arrangement



Abra Key Development Parameters

FS outcomes – Production metrics ¹		FS outcomes – Capital investment and project economics ¹	
Mill throughput	1.2Mtpa	Pre-production capital	\$170m
Initial mine life	16-years	Steady-state average EBITDA (yrs 3-15)	\$114m
Average LOM lead metal production	95ktpa	Project payback from commercial production	2-years
Average LOM silver metal production	805kozpa	Pre-tax NPV (8% discount rate)	\$553M
Lead C1 direct cash cost	A\$0.63/lb / US\$0.44/lb	Pre-tax IRR	39%

- FS assumptions are ‘spot’ as at 18 July 2019 and include: lead price US\$0.92/lb; silver price US\$16.00/oz, exchange rate of A\$1=US\$0.70 and lead treatment charge of US\$96/t of concentrate¹
- Post-tax NPV (8% discount rate) of \$381M and post-tax IRR of 32%¹
- World’s lowest cost primary lead mine (source: Wood Mackenzie)
- FS assumes product sold at benchmark terms, ie, does not include premium enjoyed by Galena under IXM offtake arrangement¹

Notes: (1) Source: FS (ASX: 22 July 2019). No reduction factor has been applied to the tonnes and grades of the Inferred Mineral Resources. Inferred Mineral Resources have a lower level of geological confidence and can't be included in the calculation of Ore Reserves, and there can be no guarantee that a revised Mineral Resource estimate update will convert Inferred Mineral Resources to Indicated Mineral Resources or return the same grade and tonnage estimation. The Mineral Resource used for the basis of the above development parameters was completed in December 2018 (ASX: 18 December 2018). Following further drilling since 2018, Galena has revised the Mineral Resource estimate (ASX: 28 April 2021).



Abra Current Status

Project completion (30 June 2021)

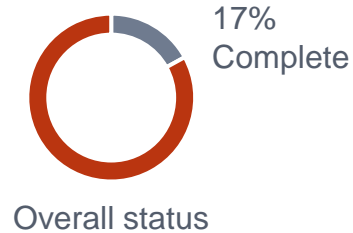

■ Contracts executed

- Processing plant EPC, site bulk earthworks, surface infrastructure (part 1), aerodrome, TSF, power, LNG supply, fuel & facilities, village services & port access
- Long lead items commitments. LNG tank, ball mill, crushers, screens, flotation cells, thickener & filter

■ Contracts being executed

- Mining, paste plant & surface infrastructure (part 2), & concentrate haulage



Abra Upcoming Development Milestones

Mining

Decline development

First Ore

Plant

Procurement & FEED

Site EPC works (construction & commissioning)

Ramp-up

Power

LNG storage & power plant construction

Infrastructure

Non-plant infrastructure (NPI)

Earthworks, TSF, aerodrome

Paste plant



Abra Exploration, Near Mine Targets

Abra Project (60%) being JV leases surrounding the Abra deposit (107 km²).

Large coincident magnetic and gravity anomalies (similar to Abra) with limited exploration

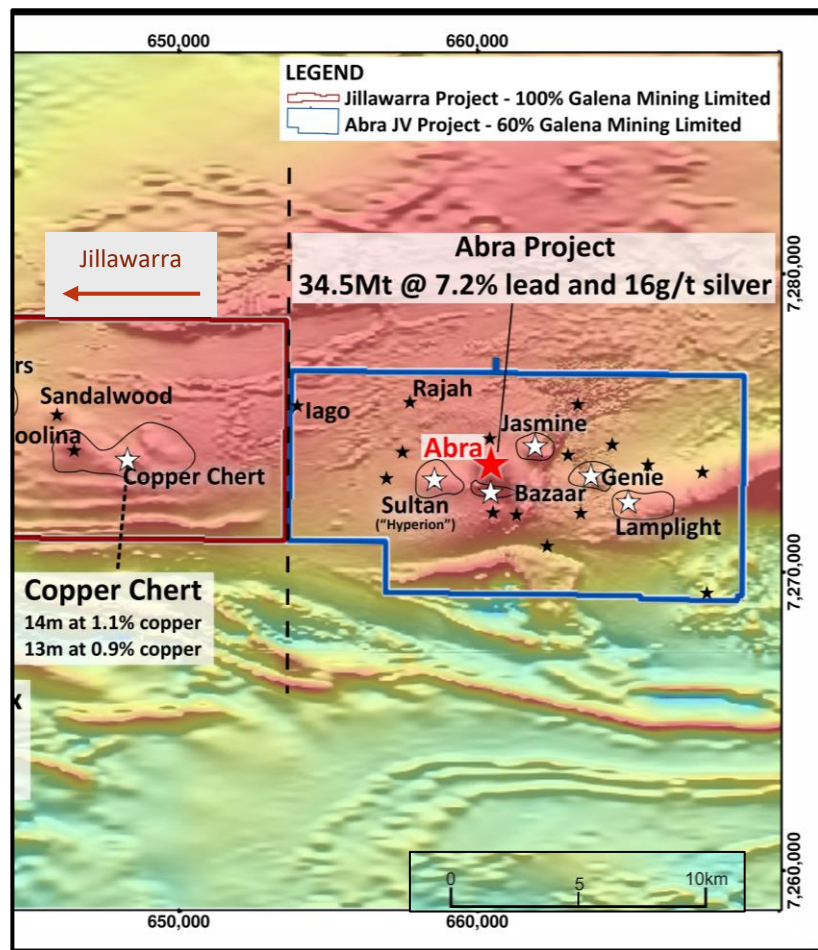

- Sultan (*Hyperion*), Jasmine, Genie & Lamplight same stratigraphic units & alteration as Abra with same geophysical signatures. Little drilling,
 - Sultan (3 holes)
 - 21m @ 4.5% lead & 23 g/t silver from 547m (Including 6m @ 9.9% lead)
 - 14.5m @ 3.1% lead & 6g/t silver from 560m (Including 3m @ 9% lead)
 - 28m @ 1.3% lead & 17g/t silver from 594m (Including 0.3m @ 17.1% lead)
 - Genie (1 hole)
 - 10m @ 4.1% lead & 17g/t silver from 594m
 - Jasmine (3 holes all missed target)
 - Lamplight (no holes)
- Bazaar possible southern extension to Abra (2 holes) drilled wrong orientation
- Rajah & Lago geophysical anomalies northwest of Abra on southern margin of Quartzite Well fault zone no drilling to date
- 11 other geophysical targets with limited exploration and drilling
- Abra gold & copper mineralisation



Abra Gold and Copper

First ever hole specifically targeting copper and gold, (AB195) provided assay results in February 2021 delivering multiple copper and gold intersections



- Significant intersection showing massive and disseminated chalcopyrite between 360m to 795m down-hole
 - 3.0m @ 4.2g/t gold and 1.1% copper from 671m
 - 1.7m @ 6.9% copper from 698m
 - 8.9m @ 2.3% copper from 773m
 - 26.9m @ 1.4% copper from 764m, including 0.8m at 8.5% copper from 773m
- Results & follow up work planning are waiting results from down-hole EM survey of AB195



Abra Gold and Copper

Emerging gold and copper zone (wireframes of copper (>0.5%) and gold (>0.5g/t) mineralisation not currently included in any resource estimation or mine plans)

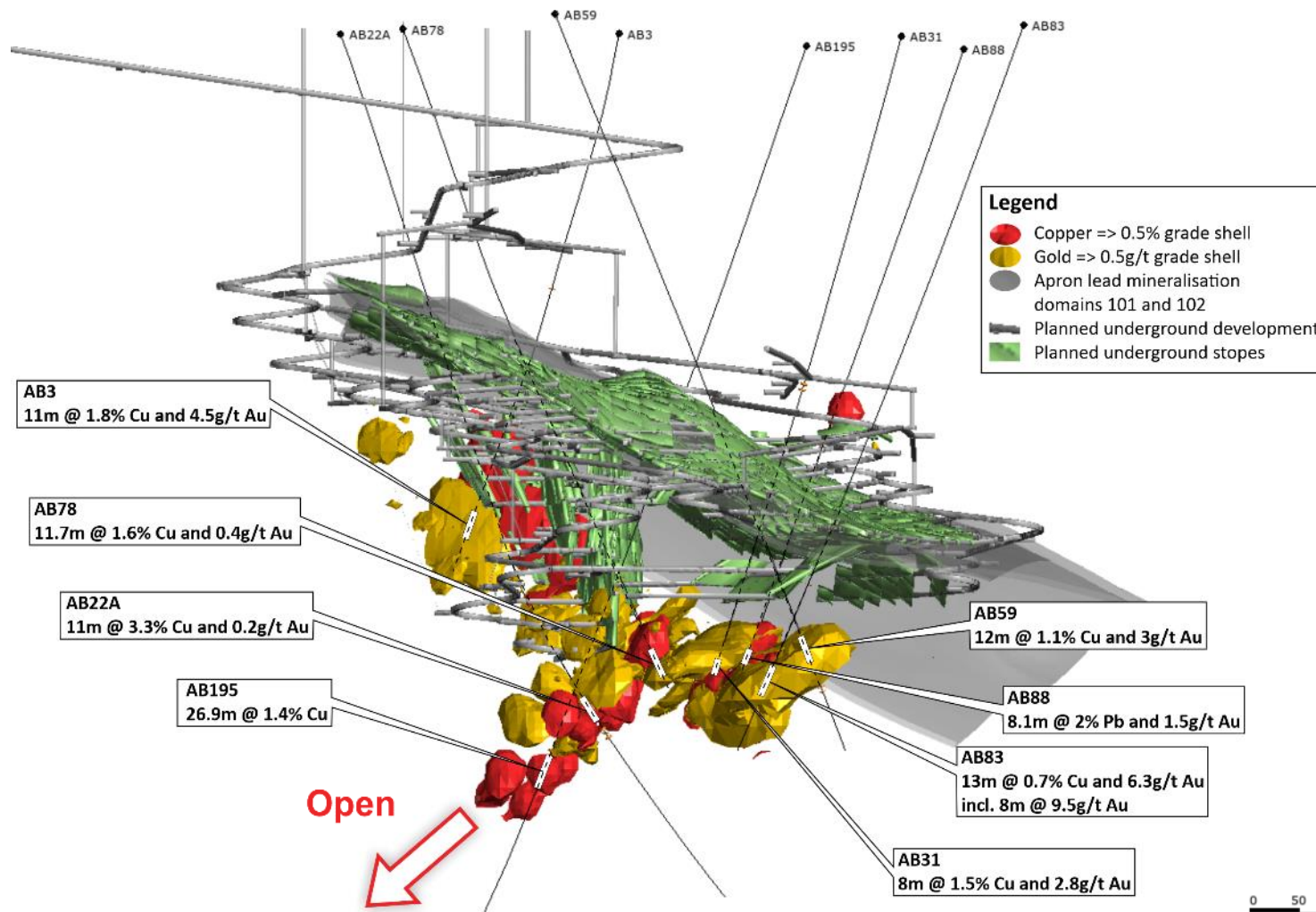

Jillawarra Project - Exploration

Galena Jillawarra Project (100%) being >76km along strike to the west of Abra (508 km²), also has large coincident magnetic and gravity anomalies (similar to Abra)

- Woodlands & Manganese Range complexes are 2 large-scale coincident magnetic and gravity anomalies along strike from Abra on the southern margin of the Quartzite Well fault
- Fencers is a “bullseye” magnetic & gravity target with limited exploration
- Copper Chert is also large geophysical target with early exploration showing near surface copper mineralisation from limited historical drilling
- Planned H2 2021 drill program targeting margins of Woodlands Complex geophysical anomalies (JHP31 & 46-40), and historical 1970’s drilling has identical geological profile to Abra

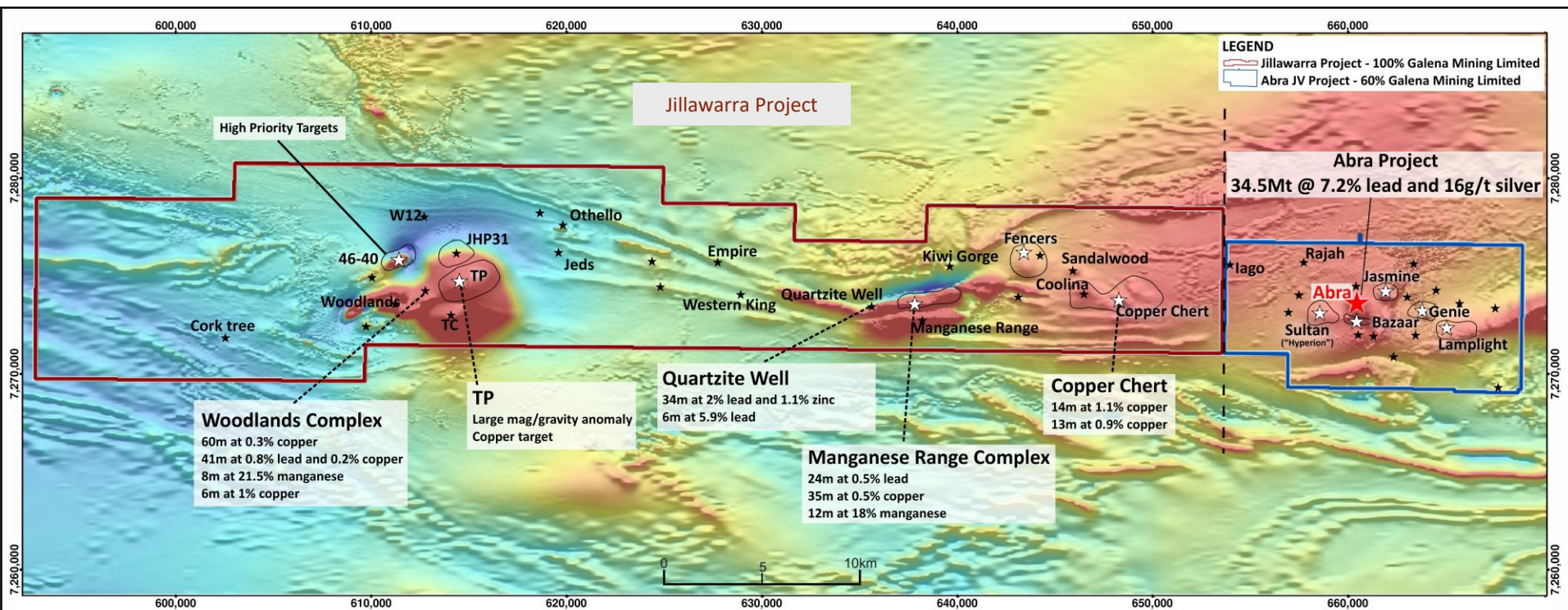

Appendix 1 - Toho Investment in Abra JV

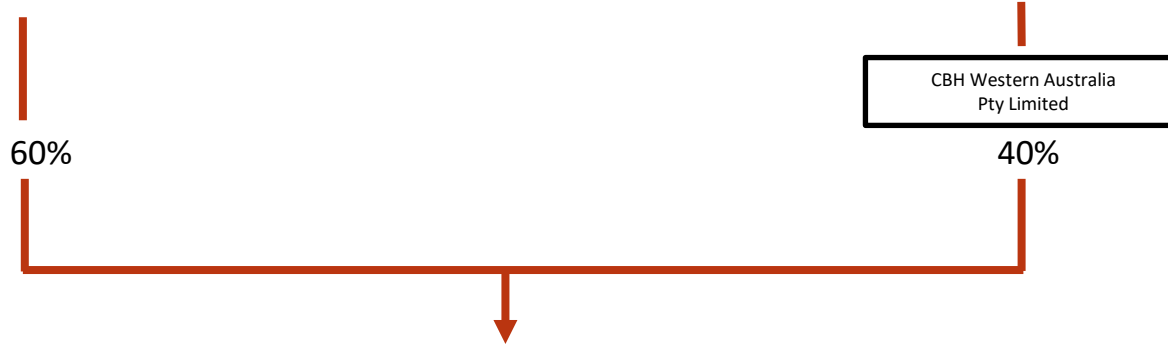

\$90M Toho Joint Venture Investment



- Definitive agreements entered into with Toho Zinc (TYO: 5707) of Japan (ASX: 12 April 2019) for investment of \$90M in tranches into Abra holding company, Abra Mining Pty Limited (AMPL)
- Full \$90M received through 2019, 2020 and 2021, with last \$40M received following Abra final investment decision (ASX:30 June 2021)
- AMPL ownership is now 40% (Toho) and 60% (Galena)
- Toho Zinc is a large-scale lead and zinc smelting company and experienced miner – In 2010 Toho acquired publicly-listed Australian lead and zinc mining company, CBH Resources Limited and continues to operate its Rasp mine in New South Wales
- Toho entered into an offtake to purchase 40% of Abra's product on 'arms length' benchmark terms
- Galena retains 60% of AMPL and appoints majority of board members to joint-venture board



Japan contributes 2% of worlds refined lead production (230-250ktpa)
 Toho top producer in Japan domestic market (100ktpa refined Lead)
 Toho imports 140-160ktpa Lead concentrate to Chigirishima

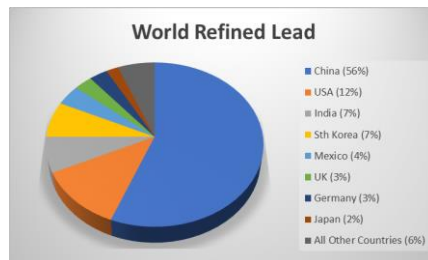
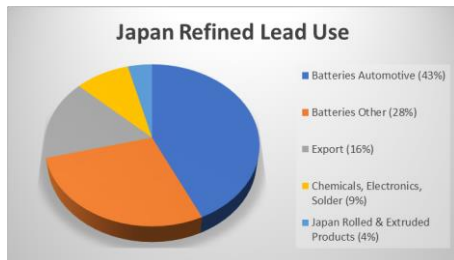

2019 – Abra JV

2010's – Open Rasp mine in NSW, Acquire 100% CBH Resources
 2000's – CBH Resources Ltd, Australia. Silver upgrade Chigirishima
 – Tianjin & Gunma Kankyo Lead recycling JV's

1990's – JV Dalian Jingya & Guang Ming Co electric components

1980's – Annaka Cadmium Oxide smelter & refinery

1970's – Lead sound insulation boards, SOFT CALM

1960's – Onahama Zinc & Fujioka Iron smelters & refineries established
 – Gran Bretana mine Peru & Qaleh Zari mine Iran

1950's – Chigirishima converted from Copper to Lead smelter & refinery

1930's – Toho Zinc Co established from Japan Zinc Smelting Co

www.toho-zinc.co.jp

TOHO investment		
Concentrate Supply	Abra	Typical Other
Time Frame	16+ years	
Qty	Min 50ktpa	
Lead grade	74 %	55 - 65 %
Silver grade	115 g/t	100 - 2,000 g/t
Deleterious Elements (DE)	1/10 th DE	DE

Chigirishima Smelter & Refinery, Hiroshima Prefecture

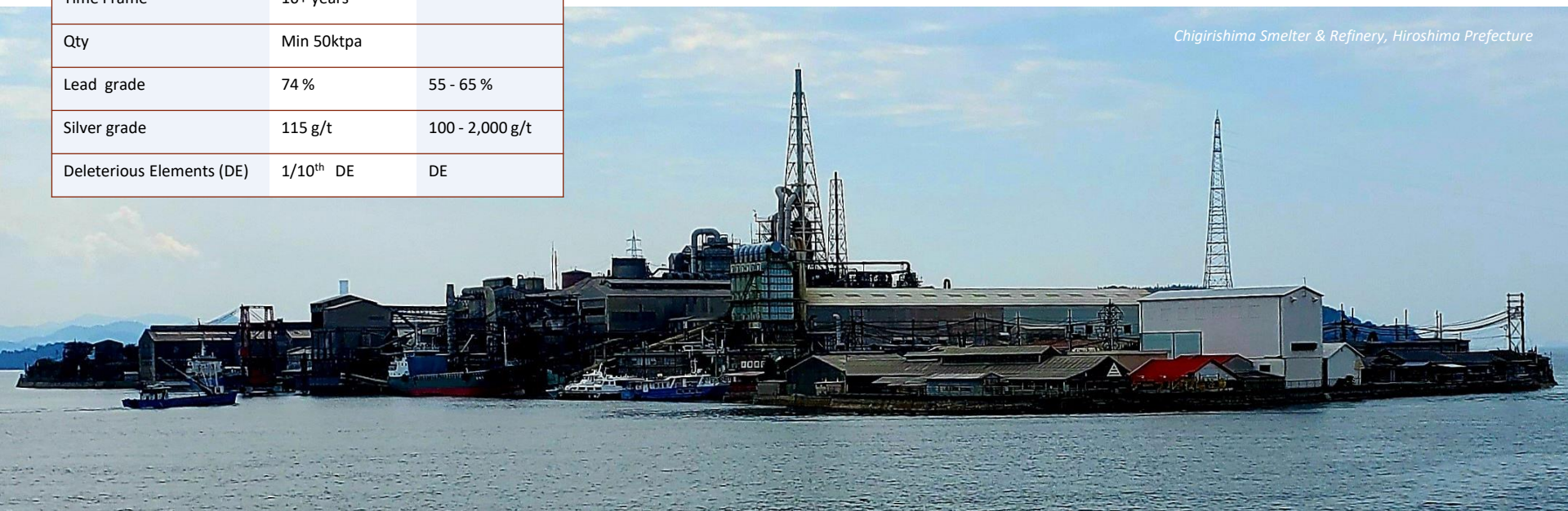



GALENA
MINING LIMITED



+61 8 6166 3750



www.galenamining.com.au



@GalenaMiningASX



Ground Floor, 1 Centro Avenue
Subiaco WA 6008, Australia